

Local Multipoint Distribution System (LMDS)

Definition

Local multipoint distribution system (LMDS) is the broadband wireless technology used to deliver voice, data, Internet, and video services in the 25-GHz and higher spectrum (depending on licensing).

Overview

As a result of the propagation characteristics of signals in this frequency range, LMDS systems use a cellular-like network architecture, though services provided are fixed, not mobile. In the United States, 1.3 MHz of bandwidth (27.5 B 28.35 GHz, 29.1 B 29.25 GHz, 31.075 B 31.225 GHz, 31 B 31.075 GHz, and 31.225 B 31.3 GHz) has been allocated for LMDS to deliver broadband services in a point-to-point or point-to-multipoint configuration to residential and commercial customers. This tutorial details the underlying technology inherent in offering voice, data, Internet, and video services over LMDS through integration with the wireline environment.

Topics

1. LMDS Overview
2. Architectural Options
3. Wireless Links and Access Options
4. Modulation
5. System Capacity
6. Microwave Propagation Issues
7. Network Planning
8. Network Node Equipment
9. Radio Frequency Equipment
10. Network Interface Equipment (Customer Premises)
11. Network Management

Self-Test

Correct Answers

Acronym Guide

1. LMDS Overview

LMDS is a broadband wireless point-to-multipoint communication system operating above 20 GHz (depending on country of licensing) that can be used to provide digital two-way voice, data, Internet, and video services (see *Figure 1*).

Figure 1. LMDS System

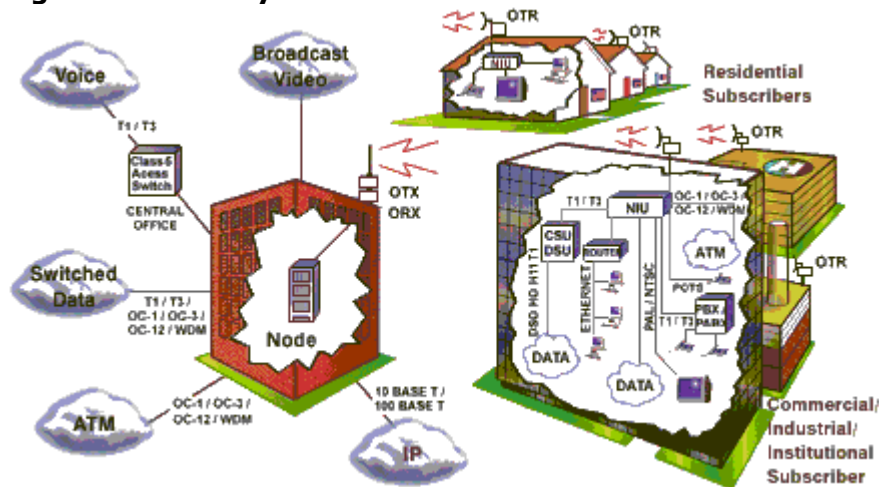

The acronym LMDS is derived from the following:

- **L (local)**—denotes that propagation characteristics of signals in this frequency range limit the potential coverage area of a single cell site; ongoing field trials conducted in metropolitan centers place the range of an LMDS transmitter at up to 5 miles
- **M (multipoint)**—indicates that signals are transmitted in a point-to-multipoint or broadcast method; the wireless return path, from subscriber to the base station, is a point-to-point transmission
- **D (distribution)**—refers to the distribution of signals, which may consist of simultaneous voice, data, Internet, and video traffic
- **S (service)**—implies the subscriber nature of the relationship between the operator and the customer; the services offered through an LMDS network are entirely dependent on the operator's choice of business

Why LMDS?

Point-to-point fixed wireless networks have been commonly deployed to offer high-speed dedicated links between high-density nodes in a network. More recent advances in a point-to-multipoint technology offer service providers a method of providing high-capacity local access that is less capital-intensive than a wireline solution, faster to deploy than wireline, and able to offer a combination of applications. Moreover, as a large part of a wireless network's cost is not incurred until the customer premises equipment (CPE) is installed, the network service operator can time capital expenditures to coincide with the signing of new customers. LMDS provides an effective last-mile solution for the incumbent service provider and can be used by competitive service providers to deliver services directly to end users. Benefits can be summarized as follows:

- lower entry and deployment costs
- ease and speed of deployment (systems can be deployed rapidly with minimal disruption to the community and the environment)
- fast realization of revenue (as a result of rapid deployment)
- demand-based buildout (scalable architecture employing open industry standards ensuring services and coverage areas can be easily expanded as customer demand warrants)
- cost shift from fixed to variable components (with traditional wireline systems, most of the capital investment is in the infrastructure, while with LMDS a greater percentage of the investment is shifted to CPE, which means an operator spends dollars only when a revenue-paying customer signs on)
- no stranded capital when customers churn
- cost-effective network maintenance, management, and operating costs

Network Architecture

Various network architectures are possible within LMDS system design. The majority of system operators will be using point-to-multipoint wireless access designs, although point-to-point systems and TV distribution systems can be

operations center (NOC), fiber-based infrastructure, base station, and CPE. This tutorial primarily discusses base-station, customer-premises, and NOC designs.

System Equipment Segments

The NOC contains the network management system (NMS) equipment that manages large regions of the customer network. Multiple NOCs can be interconnected. The fiber-based infrastructure typically consists of synchronous optical network (SONET) optical carrier (OC)–12, OC–3, and DS–3 links; central-office (CO) equipment; ATM and IP switching systems; and interconnections with the Internet and public switched telephone networks (PSTNs).

The base station is where the conversion from fibered infrastructure to wireless infrastructure occurs. Base-station equipment includes the network interface for fiber termination; modulation and demodulation functions; and microwave transmission and reception equipment typically located atop a roof or a pole. Key functionalities which may not be present in different designs include local switching. If local switching is present, customers connected to the base station can communicate with one another without entering the fiber infrastructure. This function implies that billing, channel access management, registration, and authentication occur locally within the base station.

The alternative base-station architecture simply provides connection to the fiber infrastructure. This forces all traffic to terminate in ATM switches or CO equipment somewhere in the fiber infrastructure. In this scenario, if two customers connected to the same base station wish to communicate with each other, they do so at a centralized location. Billing, authentication, registration, and traffic-management functions are performed centrally.

The customer-premises configurations vary widely from vendor to vendor. Primarily, all configurations will include outdoor-mounted microwave equipment and indoor digital equipment providing modulation, demodulation, control, and customer-premises interface functionality. The CPE may attach to the network using time-division multiple access (TDMA), frequency-division multiple access (FDMA), or code-division multiple access (CDMA) methodologies. The customer premises interfaces will run the full range from digital signal, level zero (DS–0), plain old telephone service (POTS), 10BaseT, unstructured DS–1, structured DS–1, frame relay, ATM25, serial ATM over T1, DS–3, OC–3, and OC–1. The customer premises locations will range from large enterprises (e.g., office buildings, hospitals, campuses), in which the microwave equipment is shared between many users, to mall locations and residences, in which single offices requiring 10BaseT and/or two POTS lines will be connected. Obviously, different customer-premises locations require different equipment configurations and different price points.

Standards

As LMDS wireless access systems evolve, standards will become increasingly important. Standards activities currently underway include activities by the ATM Forum, the Digital Audio Video Council (DAVIC), the European Telecommunications Standards Institute (ETSI), and the International Telecommunications Union (ITU). The majority of these methods use ATM cells as the primary transport mechanism.

2. Architectural Options

LMDS system operators offer different services and have different legacy systems, financial partners, and business strategies. As a result, the system architecture used will differ between all system operators. The most common architectural type uses co-sited, base-station equipment. The indoor digital equipment connects to the network infrastructure, and the outdoor microwave equipment mounted on the rooftop is housed at the same location (see *Figure 2*). Typically, the radio frequency (RF) planning for these networks uses multiple sector microwave systems, in which transmit- and receive-sector antennas provide service over a 90-, 45-, 30-, 22.5-, or 15-degree beamwidth. The idealized circular coverage area around the cell site is divided into 4, 8, 12, 16, or 24 sectors.

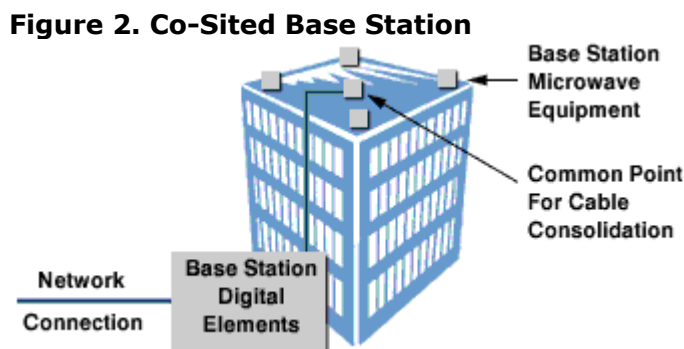

Alternative architectures include connecting the base-station indoor unit to multiple remote microwave transmission and reception systems with analog fiber interconnection between the indoor data unit (IDU) and outdoor data unit (ODU). This approach consolidates the digital equipment, providing increased redundancy, reduced servicing costs, and increased sharing of digital resources over a larger area. The difficulties are typically the lack of analog fiber resources and remote microwave transmission and reception equipment deployment issues. By using remote microwave equipment, there may be a reduced sectorization requirement at each remote location. This second alternative architecture is early in the design process for most vendors and standards bodies (see *Figure 3*).

Figure 3. Analog Fiber Architecture

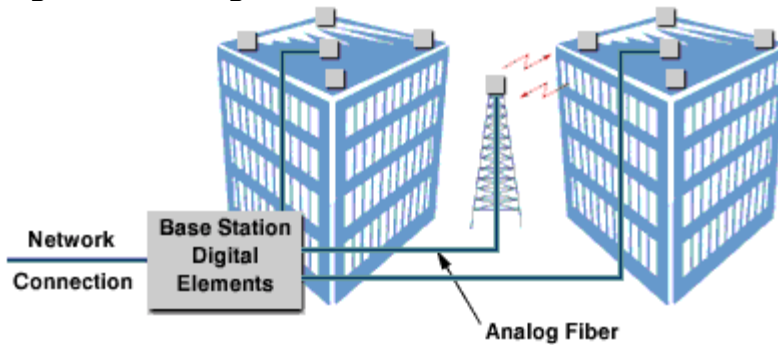

3. Wireless Links and Access Options

Wireless system designs are built around three primary access methodologies: TDMA, FDMA, and CDMA. These access methods apply to the connection from the customer-premises site to the base station, referred to as the upstream direction. Currently, most system operators and standards activities address the TDMA and FDMA approaches.

In the downstream direction, from base station to customer premises, most companies supply time division multiplexed (TDM) streams either to a specific user site (point-to-point connectivity) or multiple user sites (a point-to-multipoint system design). *Figure 4* illustrates an FDMA scheme in which multiple customer sites share the downstream connection. Separate frequency allocations are used from each customer site to the base station.

Figure 4. FDMA Access

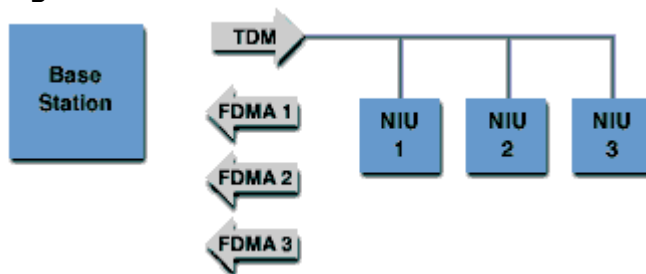
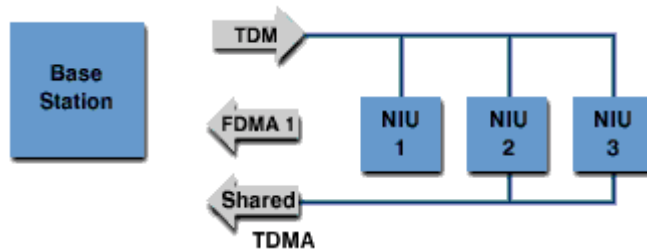

Figure 5 illustrates a TDMA scheme in which multiple customer sites share both the downstream and upstream channel.

Figure 5. TDMA Access



With FDMA and TDMA access links, whether downstream or upstream, there are a number of factors that affect their efficiency and usage. For FDMA links, the customer premises site is allocated bandwidth which is either constant over time or which slowly varies over time. For TDMA links, the customer premises is allocated bandwidth designed to respond to data bursts from the customer site. These two access methods will probably provide the majority of access links for LMDS systems over the next few years. The choice between these access links is directly related to the system operator business case, service strategy, and target market.

Large customer premises may require a wireless DS-3 or multiple unstructured DS-1 connections. A customer might purchase the use of this wireless connection with the understanding that the bandwidth is available 24 hours a day. In this case, FDMA access links make sense, because the user is paying for and receiving dedicated bandwidth over the wireless access system as well as over the network infrastructure. Typically, the FDMA links terminate in a dedicated FDMA demodulator circuit within the base station.

The other extreme customer case could be customer premises sites that require a single 10BaseT port for Internet access. These users have very low upstream data requirements (acknowledgment packets and data requests are the primary traffic) but may have fairly large downstream data requirements. In this case, TDMA access makes sense, allowing multiple low-data rate users to share a single channel. In addition, the base station terminates the TDMA access link in a single modem, allowing multiple customers to share the single modem at the base station.

Most system operators will have a service mix and target market that lies between these two cases. The choice of TDMA and/or FDMA access methods within the system becomes an issue both for the system designer and the system operator.

As a final example, suppose a system operator wishes to serve a six-story office building containing 20 employees per floor. This offers a total POTS line count of 120. Each office currently uses various mixtures of frame relay, DS-1, fax lines, and modem lines. Some offices wish to connect their in-office Ethernet local-area network (LAN) to the wide-area network (WAN) using routers. The system

operator knows that only a percentage of the offices will switch to a wireless service provider.

How does a system operator decide when to use TDMA and when to use FDMA? First, it is necessary to estimate the peak and average expected traffic data rate from all of the potential or estimated offices. Second, it is important to determine which traffic may be multiplexed and traffic-shaped to smooth out the traffic burstiness. If the resulting burstiness is smooth enough, the upstream traffic requirements can be handled effectively using FDMA techniques. Alternately, if burstiness persists within the traffic stream, TDMA may be a better choice.

There are additional system issues relating to the choice of TDMA and FDMA such as the efficiency of the wireless medium access control (MAC), customer-premises multiplexer efficiency, channel structure efficiency, amount of forward error correction (FEC) used on the channel, maximum data rate during peak hours, sharing of the base-station equipment during commercial off-peak hours, blocking levels allocated to the wireless access links, asymmetrical and symmetrical traffic mixtures, and link distance which can be sustained for the various access methods. These issues are discussed in *Table 1*.

Table 1. TDMA and FDMA System Issues

Issue	TDMA	FDMA
user burstiness efficiency	TDMA allows for bursty response and does not request slots unless necessary.	FDMA link is always on, regardless of whether or not the user sends data.
wireless MAC	MAC efficiency ranges from 65–90 percent or higher depending on the burstiness characteristics of the users and the MAC design.	Efficiency is estimated at 100 percent, no MAC.
customer-premises mix	Both the FDMA and TDMA systems allow higher-priority user traffic to be sent first.	Both systems multiplex various streams through the same wireless pipe.
channel efficiency	Efficiency is estimated at 88 percent, based on preamble and ranging.	Efficiency is 100 percent.
FEC percent	75 to 85 percent	91 percent
maximum data rate	TDMA allows bursting to the maximum rate of the channel, based on fairness algorithms for the wireless MAC and the customer-premises multiplexer.	FDMA provides a constant pipe, with bursting occurring based on fairness algorithms within the customer-premises multiplexer.

4. Modulation

Modulation methods for broadband wireless LMDS systems are generally separated into phase shift keying (PSK) and amplitude modulation (AM) approaches. The modulation options for TDMA and FDMA access methods are almost the same.

The TDMA link modulation methods typically do not include the 64–quadrature amplitude modulation (QAM), although this might become available in the future. The FDMA access modulation methods are listed in *Table 2* and are rated on an estimated scale as to the amount of bandwidth they require for a 2–Mbps constant bit rate (CBR) connection (without accounting for overhead due to ATM and FEC). Values are approximate, as there are issues involving channel filter mask roll-off factors, which can be important when providing the relationship between microwave bandwidth and data rates.

Table 2. FDMA Access Modulation Methods

Name	Modulation Method	MHz for 2 Mbps CBR Connection
BPSK	binary phase shift keying	2.8 MHz
DQPSK	differential QPSK	1.4 MHz
QPSK	quaternary phase shift keying	1.4 MHz
8PSK	octal phase shift keying	0.8 MHz
4–QAM	quadrature amplitude modulation, 4 states	1.4 MHz
16–QAM	quadrature amplitude modulation, 16 states	0.6 MHz
64–QAM	quadrature amplitude modulation, 64 states	0.4 MHz

5. System Capacity

The system capacity for LMDS systems can be measured in terms of data rate and maximum number of customer premises sites.

Data-Rate Capacity—FDMA Access

For data-rate calculations, LMDS system capacity is equal to the number of cell sites within the system multiplied by the capacity per cell site. The cell site capacity is equal to the number of sectors within the cell site times the sector capacity. To provide basic examples, assume the values in *Table 3* for spectral

efficiency. Spectral efficiency is measured in bits per second per Hertz (b/s/Hz) and is a basic figure of merit for different modulation schemes.

Table 3. Spectral Efficiencies

Modulation	Spectral Efficiency
4-QAM	1.5 b/s/Hz
16-QAM	3.5 b/s/Hz
64-QAM	5 b/s/Hz

Using these spectral efficiencies, and assuming 1,000 MHz of useable spectrum with a frequency reuse of 2, the LMDS system provides 500 MHz of useable spectrum per sector. Assuming symmetrical upstream and downstream links, there is 250 MHz in each direction per sector. The sector capacities are shown in the following examples:

Example 1

If each customer-premises site uses 5-MHz FDMA links at QAM-4 modulation, this provides $5 \times 1.5 = 7.5$ Mbps per customer site. There are $(250/5) = 50$ of these links, providing a total of 375 Mbps upstream. The downstream links also use 4-QAM modulation, providing 375 Mbps.

Example 2

If each customer-premises site uses 5-MHz FDMA links at 16-QAM modulation, this provides $5 \times 3.5 = 17.5$ Mbps. There are 50 of these links, providing a total of 875 Mbps. The downstream links also use 16-QAM modulation, providing 875 Mbps.

Example 3

If each customer-premises site uses 5-MHz FDMA links at 64-QAM modulation, this provides $250 \times 5 = 1250$ Mbps upstream. The downstream links also use 64-QAM modulation, providing 1250 Mbps.

It is possible to have more capacity per sector than can be used within the coverage areas. For this reason, LMDS systems will probably be range-limited rather than capacity-limited. One option to increase range is to move to lower-modulation constellations. The values provided are examples only and may not reflect the full scope of equipment capability.

Maximum Number of Customer-Premises Sites—FDMA Access

In the previous calculations it was assumed that the FDMA channel bandwidth was 5 MHz. Using this assumption to calculate the total number of users, there are $250 \text{ MHz} / 5 \text{ MHz} = 50$ customer sites per sector. The number of sectors dictates the number of total customer sites per cell site. The customer site may be a large office building with many offices, all connected to the base station through the same 5-MHz channel.

Data-Rate Capacity—TDMA Access

TDMA systems have a reduced data-rate capacity compared to FDMA systems in the range of 80 percent. Also, TDMA systems do not use 64-QAM modulation; as a result, the very dense data rates achievable in FDMA systems are not available. However, 64-QAM modulation is useful only on shorter links as a result of the increased signal levels required for its operation. Therefore, 64-QAM FDMA access is only useful when the dense data-rate customers are close to the base station site.

Maximum Number of Customer-Premises Sites—TDMA Access

TDMA systems are the best choice when many low-data rate users must be serviced. For example, it is assumed that a 250-MHz upstream bandwidth is available within the LMDS system (same as before) and that 5-MHz TDMA channels are used. Each 5-MHz TDMA channel can provide approximately 80 DS-0 connections simultaneously. The total number of simultaneous DS-0 users on the TDMA system per sector are $80 \text{ DSos per channel} \times (250/5) = 4,000$.

The total number of simultaneous DS-0 users over the cell depends on the number of sectors. If typical values of concentration over the entire sector and cell are assumed to be in the range of 5:1, this TDMA system allows for a total of 20,000 DS-0 connections per sector within the blocking level probabilities consistent with telecommunications system design. We have assumed a 5:1 concentration level to reflect some Internet usage (telephone modems) over these DS-0 connections. There may also be some fax lines.

As in the case of the earlier FDMA example for data rate, 20,000 DS-0 lines per sector is excessive with respect to the coverage area of these LMDS systems. If 10 sectors were used, this would imply that 200,000 DS-0 lines could be supported. The typical coverage distances for LMDS systems are in the range of 3 km to 5 km

for 99.99 percent service in the various rain regions, so 200,000 lines is too many.

Based on these numbers, it is important to look at the combined effect of TDMA and FDMA access methods in order to address all data rate and customer site requirements.

6. Microwave Propagation Issues

An area of continuing research for LMDS systems relates to microwave propagation behavior. The LMDS systems at 28 GHz are most susceptible to rain effects causing a reduction in the signal level. The Comité Consultatif International des Radiocommunications (CCIR) has rainfall attenuation estimation procedures; however, there is limited data and experience in small cell point-to-multipoint systems. Rainfall causes depolarization of the signals, leading to decreased signal level and decreased interference isolation between adjacent sectors and adjacent cell sites. Additional propagation issues relating to foliage also need further study.

The primary propagation issue in lower-frequency bands is multipath fading. At the LMDS frequencies, multipath fading should not be an important effect. First, LMDS frequencies are much more line-of-sight (LOS)-dependent, which means that shadowing and diffraction do not occur as often at lower frequencies. Second, cellular and personal communications service (PCS) systems typically have customer-premises locations within six feet of the ground, whereas LMDS systems have customer antennas located high on rooftops. The height of the customer-premises antenna plays a large role in reducing multipath effects. Third, the LMDS antennas are highly directional (pointing to a single cell site), whereas the cellular and PCS antennas have either omnidirectional or loosely sectorized characteristics. Using directional antennas reduces multipath effects. Fourth, in cellular and PCS systems the customer antenna may be moving, whereas LMDS antennas are fixed on a rooftop. Once an antenna becomes fixed, installers can choose better case locations on the rooftop, leading to improved performance.

Considering these factors, the cell coverage distance will vary depending on the rainfall statistics in the particular area. Foliage height in relation to commercial and residential building heights also needs to be examined to determine the percentage of building rooftops that can be illuminated from any particular base-station antenna sector.

It is interesting to consider the approximate cell sizes that are possible within the LMDS systems. Over time these cell sizes will increase based on the microwave-power amplifier technology advances. Cell sizes are strongly affected by the propagation environment. Items such as foliage, rainfall rates, height of the

transmit (cell site) antenna, and height of the customer-premises antenna are primary factors that must be considered. When detailed cell-site coverage area planning is done, it is necessary to account for the local obstructions and terrain and topology details that may affect the distance that the cell site can support. The following maxims hold true:

- As the required availability of the link increases, the distance decreases. For example, if a system operator is providing a service that requires 99.9 percent availability, the link distance may be up to 14 km. Customers at the distance 8.5 miles (14 kms) from the cell site will not receive service for eight hours a year, and customers closer to the cell site will have availability, which is better. However, if the system operator chooses to provide services that require 99.99 percent availability, the cell coverage distance may be reduced to 3 miles (5 km). If the system operator provides services that require 99.999 percent availability, the cell coverage distance is reduced to 1.5 miles (2.5 km). These numbers are approximate and depend on details specific to each vendor's system design.
- The modulation choice affects the distance as well. For example, QPSK and 4-QAM distances may be 6 miles (10 km), whereas 16-QAM coverage distance could be 3 miles (5 km) and 64-QAM distances could be 1.5 miles (2.5 km).
- The coverage distance also depends on the rain region. For example, LMDS systems in Miami and New Orleans might support a distance of 2 miles (3 km) at 99.99 percent. The same LMDS system design in Denver might support a distance of 3 miles (5 km) or more. This implies that the economics of providing telecommunications services using LMDS technology will vary depending on the area being served.

7. Network Planning

Cell Design

When planning the cell sites for an LMDS network, it is important to take the following attributes into consideration:

subscriber penetration—Distribution system performance is measured by subscriber penetration—the percentage of subscribers having sufficient signal level to achieve excellent service quality.

quality of service (QoS)—QoS can be affected by several factors, including transmission path obstruction, cell overlap (15 percent is normal), and system redundancy.

link budget—Link budget is used to estimate the maximum distance that a subscriber can be located from a cell site while still achieving acceptable service reliability. The budget accounts for all system gains and losses through various types of equipment. The link budget analyzes several network parameters, including carrier-to-noise ratios (CNRs); carrier-to-composite triple beat ratios; and self-repeat site interference (C/I) and link fade margins. In some cases, the microwave equipment is channelized to support a single carrier. Other systems offer broadband multichannel capability in which multiple carriers can be supported through a single transmitter.

cell-size selection—The maximum cell size for the service area is related to the desired reliability level obtained from the link budget. Cell size can vary within a coverage area due to the type of antenna, its height, and signal loss. These effects are generally related to the coverage area service type such as urban, suburban, or low-density coverage. Cell-size selection affects the total capital cost for the required coverage area.

capital-cost model—The capital-cost model is used to estimate the network capital requirements. The required model encompasses design considerations such as link budget, cell size, cell overlap, number of cells, traffic capacity, number of sectors, capital cost per cell, and total capital cost.

Frequency Reuse Optimization

The following techniques are used to optimize the frequency reuse of LMDS networks:

- minimization of multipathing and cross-polarization by using highly directional antennas and by positioning them as high as possible
- maximization of the directivity of the cell antennas by sectoring the distribution system; the cell-site microwave equipment is generally configured with multiple sectors, antennas, transmitters, and receivers. A typical configuration is a four-sector cell site using 90-degree beamwidth antennas to provide services to the subscriber environment.

Each of these sectorized antennas (transmitters and receivers) can support the full bandwidth of the allocated spectrum.

- maximization of the isolation between the adjacent sectors through polarization; horizontal (H) and vertical (V) polarization can be employed throughout the system in an alternate pattern between the sectors, as shown in *Figure 6*. The H and V polarization is also reused throughout the system.

Figure 6. Horizontal and Vertical Polarization Reuse

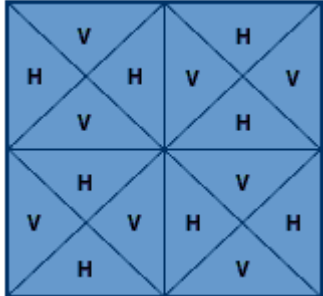

8. Network-Node Equipment

The network-node equipment (NNE) provides the basic network gateway for connecting wireline network traffic to the LMDS bandwidth (see *Figure 7*). The NNE is equivalent to the base-station digital equipment. The network-node products provide processing, multiplexing, demultiplexing, compression, error detection, encoding, decoding, routing, modulation, and demodulation. The NNE may also provide ATM switching.

Figure 7. Network Node Architecture

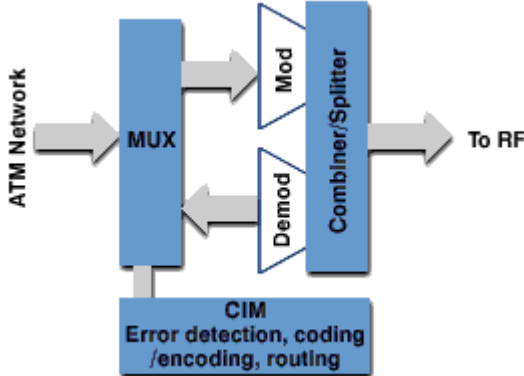

The following functions may be performed at the network node:

Digital Signal Compression

The conversion of analog television signals to highly compressed digital signals for distribution by the microwave system.

Wireline/Wireless Protocol Interfaces

Depending on an operator's service offerings, NNE may be configured to extend video, IP, and voice services over LMDS bandwidth. (ATM is emerging as a likely standard for the delivery of voice, data, Internet, and video services over LMDS.)

Modulation and Demodulation

Signals from the voice, video, and data multiplexing system are modulated before wireless transmission occurs. Similarly, traffic from the microwave receiver is demodulated before wireline transmission.

Modulation

A digital modulator accepts a digital stream and provides a 4-QAM, 16-QAM, or 64-QAM intermediate frequency (IF) signal for delivery over the LMDS bandwidth. The modulator performs all the functions required to modulate digital video, voice, and data to a standard IF for input to the wireless transmitters.

Demodulation

A QAM demodulator contains two separately addressable demodulator channels, each capable of accepting 4-QAM, 16-QAM, 64-QAM signals at symbol rates between 1 Mbps and 10 Mbps. TDMA systems may use differential QPSK modulation.

9. Radio Frequency Equipment

Network Node

LMDS network node RF equipment includes transmitters and receivers as well as transceivers and the antennas they feed. If there is one carrier per transmitter, the system is said to be channelized. If there are multiple carriers per transmitter, the system is said to be broadband.

Transmitters

Individually modulated signals are combined and applied to the broadband transmitter. Within the transmitter, the very-high-frequency (VHF) signals are converted up to the desired carrier frequency, amplified, and applied to the antenna for transmission. Separate transmitters, receivers, and antennas can be used in each direction to minimize the near-end crosstalk effects between transmit and receive signals.

Receivers

A separate broadband receiver receives the entire band at carrier frequency and converts the signals to the VHF band. The VHF signals are then applied to coaxial or fiber cable for distribution to the NNE.

Transceivers

Combined transmitter and receiver functions can be provided in a single broadband transceiver.

Antenna Systems

Antennas are chosen based on the desired coverage of potential subscribers, taking into consideration the terrain, interfering objects, antenna azimuth pattern, antenna elevation pattern, and antenna gain.

Customer-Premises Site

Transceiver

For two-way data network applications, a transceiver is used to provide a return path for LMDS services. The antenna may be an integral part of the transceiver. The transceiver may be broadband or channelized.

Customer Antenna Systems

Typical technology choices available include microstrip design, parabolic and grid-parabolic reflectors, and horn designs. The selection is an engineering decision based on the customer's location. As well, vendors will have various levels of integration with specific antenna technologies.

10. Network Interface Equipment (Customer Premises)

At the customer-premises site, a network interface unit (NIU) provides the gateway between the RF component and in-building appliances. NIUs are manageable by the network management system provided in the network-control center (see *Figure 8*). These NIUs are available in scalable and nonscalable forms depending on customer requirements.

Figure 8. NIU Network Implementation

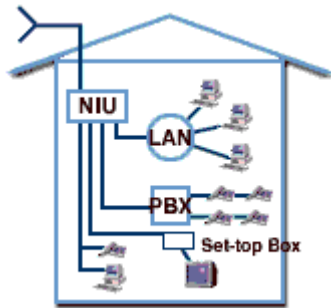

Fully Scalable/Configurable NIU

A scalable NIU is flexible, fully configurable, and chassis-based. It is located at the subscriber site and supports two-way digital wireless voice, data, and video communications for commercial and business uses. The NIU can be configured with 10BaseT, analog voice, structured and unstructured T1/E1, T3/E3, OC-1, OC-3/STS-3 fiber communications, ATM 25.6, and video communications in a single chassis.

As part of the wireless broadband network, the NIU communicates with the base-station equipment through a two-way transceiver forming a part of the point-to-multipoint network solution. This solution allows network operators to deploy their services instantly without the need for building the subscriber wireline infrastructure, thereby, capturing the rapidly growing telecommunications market just in time.

The NIU's basic building blocks consist of the following components:

- a radio-modem module supporting 4, 16, and 64-QAM and featuring either FDMA or TDMA access mode
- a data-processor module (DPM) supporting various services such as T1/E1, 10BaseT, and ATM 25.6 services through an ATM SARIing processor

- a chassis-interface module (controller providing processing resources)
- aA power supply

Modular design of the NIU allows network operators to meet each subscriber's requirements efficiently. The network operator can configure multiple radio modems to support the total bandwidth required by the configured services. The NIU should work in conjunction with the broadband microwave system to maximize the use of available RF-spectrum resources. The radio-modem and DPM ratios can be optimized with mix and match options from one-to-one mapping to multiplexing the data streams from several DPMs.

Nonscalable NIU

A nonscalable NIU is a stand-alone, cost-effective piece of CPE that provides a fixed combination of interfaces. The combination is designed to meet the requirements of small- to medium-sized business market segments. Services may include structured and unstructured T1/E1; T3/E3; 10BaseT; video; POTS; frame

11. Network Management

LMDS network management is designed to meet a network operator's business objectives by providing highly reliable network management services. Network management requires the following:

Fault Management

This is necessary to identify, localize, and correct errors or faults in the network. Each device within a wireless network should be monitored for troubleshooting or performance. All LMDS devices collect and report statistics pertaining to traffic throughput, boundary condition violations, and management activities.

Configuration Management

This is necessary in order to provision, inventory, initialize, and back-up network resources. The LMDS equipment should be auto-discovered when new equipment is added to a node. This minimizes the amount of provisioning needed to install or upgrade equipment.

Accounting Management

This is necessary to collect and process billing information. Each manageable node in the wireless portion of the network should maintain a collection of statistics that can be accessed by a third-party billing system as input. Users should be identified on a per-network user basis.

Performance Management

This is necessary to collect, filter, and analyze network resource statistics. There are a number of parameters that should be monitored and configured on each network node, from T1 traffic throughput to output power level. The management station should monitor these parameters and adjust them to increase performance.

Security Management

All information transmitted through the wireless environment must be encrypted between each node in the network. The security-management function should automatically generate and coordinate the keys used to encrypt and decrypt, as well as to authenticate users.

The management application at the base station should not be a stand-alone management application. It must provide a mechanism to populate the cell-based information in the node's management information base. For the next few years, dedicated platforms may be required to provide end-to-end management of the complete LMDS system.

Self-Test

1. LMDS is an acronym for which of the following?
 - a. linked multipoint digital service
 - b. local multipoint distribution service
 - c. low-speed multiple data streams
 - d. local multimedia distribution service
2. In which of the following bands does LMDS in the United States not operate?
 - a. 27.5–28.35 GHz
 - b. 29.1–29.25 GHz
 - c. 31.075–31.225 GHz
 - d. 40.5–42.5 GHz
3. Which of the following is used to estimate the distance that a subscriber can be located from a cell while still achieving acceptable service reliability?
 - a. cell-size selection
 - b. link budget
 - c. capital-cost model
 - d. cell design
4. Network-node products provide which of the following?
 - a. multiplexing and demultiplexing
 - b. encoding and decoding
 - c. modulation and demodulation

- d. all of the above
5. The radio-modem module of the NIU supports which of the following?
- a. 4, 16, and 64-QAM
 - b. FDMA
 - c. TDMA
 - d. all of the above
6. When calculating the data rates for LMDS, capacity is the number of cell sites within the system multiplied by which of the following?
- a. the capacity per cell site
 - b. the number of cells
 - c. the number of sectors in the cell site
 - d. the sector capacity
7. Which of the following is not included in LMDS network management?
- a. fault management
 - b. configuration management
 - c. accounting management
 - d. tower management
8. LMDS optimizes frequency reuse by doing which of the following?
- a. minimizing multipathing
 - b. cross polarization
 - c. sectoring the distribution system
 - d. all of the above
9. The choice of antennas used within an LMDS network is based on which of the following?
- a. desired subscriber coverage

- b. terrain and interfering objects
- c. antenna azimuth pattern, elevation patter, and gain
- d. all of the above

Correct Answers

1. LMDS is an acronym for which of the following?
 - a. linked multipoint digital service
 - b. local multipoint distribution service**
 - c. low-speed multiple data streams
 - d. local multimedia distribution service
2. In which of the following bands does LMDS in the United States not operate?
 - a. 27.5–28.35 GHz
 - b. 29.1–29.25 GHz
 - c. 31.075–31.225 GHz
 - d. 40.5–42.5 GHz**
3. Which of the following is used to estimate the distance that a subscriber can be located from a cell while still achieving acceptable service reliability?
 - a. cell-size selection
 - b. link budget**
 - c. capital-cost model
 - d. cell design
4. Network-node products provide which of the following?
 - a. multiplexing and demultiplexing
 - b. encoding and decoding
 - c. modulation and demodulation

- d. all of the above**
5. The radio-modem module of the NIU supports which of the following?
- a. 4, 16, and 64-QAM
 - b. FDMA
 - c. TDMA
 - d. all of the above**
6. When calculating the data rates for LMDS, capacity is the number of cell sites within the system multiplied by which of the following?
- a. the capacity per cell site**
 - b. the number of cells
 - c. the number of sectors in the cell site
 - d. the sector capacity
7. Which of the following is not included in LMDS network management?
- a. fault management
 - b. configuration management
 - c. accounting management
 - d. tower management**
8. LMDS optimizes frequency reuse by doing which of the following?
- a. minimizing multipathing
 - b. cross polarization
 - c. sectoring the distribution system
 - d. all of the above**
9. The choice of antennas used within an LMDS network is based on which of the following?
- a. desired subscriber coverage

- b. terrain and interfering objects
- c. antenna azimuth pattern, elevation patter, and gain
- d. all of the above**

Acronyms

AM

amplitude modulation

ATM

asynchronous transfer mode

BRI

basic-rate interface

CBR

constant bit rate

CCIR

Comite Consultatif International des Radiocommunications

CDMA

code-division multiple access

C/I

cite interference

CNR

carrier-to-noise ratio

CO

central office

CPE

customer-premises equipment

DAVIC

Digital Audio Video Council

DPM

data-processor module

DS-o

digital signal, level o

ETSI
European Telecommunications Standards Institute

FDMA
frequency-division multiple access

FEC
forward error correction

IDU
indoor data unit

ISDN
integrated services digital network

IF
intermediate frequency

IP
Internet protocol

ISP
Internet service provider

ITU
International Telecommunications Union

LAN
local-area network

LMDS
local multipoint distribution service

LOS
line of sight

MAC
medium-access control

NIU
network interface unit

NMS
network management system

NNE
network node equipment

NOC

network operations center

OC

optical carrier

ODU

outdoor data unit

PCS

personal communications service

POTS

plain old telephone service

PRI

primary-rate interface

PSK

phase shift keying

PSTN

public switched telephone network

QAM

quadrature amplitude modulation

QoS

quality of service

QPSK

quadrature phase shift keying

RF

radio frequency

SAR

segmentation and reassembly

SOHO

small office home office

SONET

synchronous optical network

TDM

time-division multiplexed

TDMA

time-division multiple access

VHF

very-high frequency

WAN

wide-area network